

SPA INSTRUCTION SHEET

EN

Installation

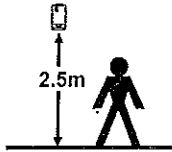

Using the fixings provided secure the backplate to the wall at 2.5 metres above the floor. To obtain optimum performance do not site the unit close to air extraction.

1. Open cover using key provided.
2. Open battery cover using key in direction of arrows, see below. Insert 2 "D" cell batteries observing correct orientation.
3. Close the battery cover and insert an aerosol refill. *N.B* after 30 seconds unit will dose and adopt default settings if a custom programme has not been selected.
4. For programming see section opposite.

Dimensions

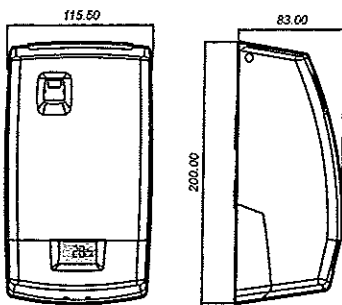

Battery Cover

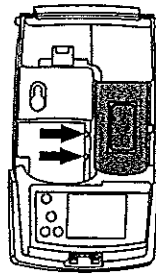

Inserting/Replacing Can

INSERTING FIRST CAN

Insert can.
Press MENU for two seconds to unlock keypad.
Follow programming instructions.

REPLACEMENT CAN

Insert new can.
For users who have selected 'Show Days Left,' press MENU for 2 seconds then press 'NEW CAN' to reset visible countdown.

Default Settings

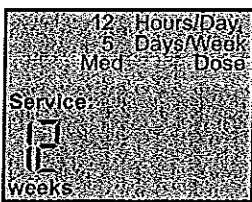

12 hours/Day
5 Days/Week
Med Dose
Time = 09:00 (24 hour clock)
Start Time = 07:00 (24 hour clock)
Today = Monday
Days Off = Sat & Sun
Show Days Left = NO
Battery Alarm = OFF

N.B If no buttons are selected within a 30 second interval the unit will adopt the default settings.

Low Battery Indication

If 'Show Days Left NO' has been selected when battery life is low the battery icon will show one flashing segment and the screensaver icon will change to one square only.



If 'Show Days Left YES' has been selected when battery life is low, the battery icon will show one flashing segment and the word 'Battery' will flash.

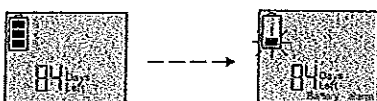

Programming

MENU

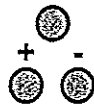

Press and hold MENU button for 2 seconds to unlock keypad.

Press +/- to scroll between settings.

N.B At any stage, press and hold MENU to return to start of programming sequence.

- 1 Press MENU
Select hours of operation (+/-) 12 or 24.



- 2 Press MENU
Select days of operation (+/-) 5 or 7.



- 3 Press MENU
Select dose level (+/-) HI/Med/Low or X-Low.



- 4 Press MENU
Set current time (+/-) *N.B.* for 12 hour setting only.

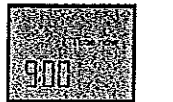

- 5 Press MENU
Set start time (+/-) *N.B.* for 12 hour setting only.



- 6 Press MENU
Set current day (+/-) *N.B.* for 5 day setting only.

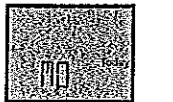

- 7 Press MENU
Set days off (+/-) *N.B.* for 5 day setting only.



- 8 Press MENU
Select Show days left (+/-)
NO for Screensaver.

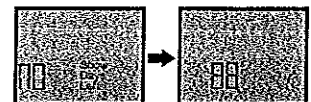

YES for countdown to next service.

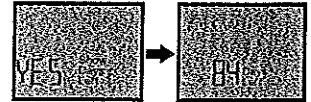

- 9 Press MENU
Select Battery alarm (+/-) OFF or ON for audible alarm.

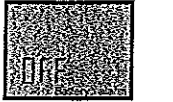

- 10 Press MENU
Programming completed.



The unit will dose automatically.

KENNEDY HYGIENE PRODUCTS LIMITED
Brookside - Uckfield
East Sussex - TN22 1YA
United Kingdom
Tel: +44 (0) 1825 768141
Fax: +44 (0) 1825 768143
e-mail: sales@kennedy-hygiene.com
Website: www.kennedy-hygiene.com

